

A Higher Level of Performance



Data Sheet

Ranger One™ LTRP-1 Ultrasonic Level Transmitter



For more information, please visit >
www.hawkmeasurement.com

Overview

Ranger One™ LTRP-1
Ultrasonic Level Transmitter



Principle of Operation

The Ranger One™ ultrasonic level transmitter has a maximum range of 14 feet (4.3 meters). Like all Ranger sensors, it's built for durability and ease of use in tough industrial environments. The Ranger One™ is unique in the Ranger family of products because it can be applied to any liquid tank level application and much more. The Ranger One™ is an ideal solution for position or distance measurement in factory automation like web control or heavy equipment monitoring as well as solids level remote monitoring on anything from corn flakes to sawdust. It's fully submersible, corrosion resistant, shock resistant ultrasonic sensors are housed in 316 stainless steel and all around tough. The Ranger One™ sensors contain a rugged transducer potted in a stainless steel housing for long life. Outputs respond to measured distance and non-contact technology means nothing touches your materials. It's also fully configurable with our software. Ranger One includes our famous "Teach" feature for push button configuration. You can quickly adjust, optimize, save and clone your applications without calibration. The Ranger One™ has Multi-Sensor network capabilities using the Smart Communications via Modbus protocol, RS-485. The Ranger One™ would typically replace conventional ultrasonic level sensors PLUS proximity sensors and proximity switches. A proximity sensor is a sensor able to detect the presence of nearby objects without any physical contact. The Ranger One's Unique Ultrasonic Signal Processing is impervious to most sensing targets and can be used in almost every industrial application without regard to the target material. This compact sensor is used around the world on remote liquid level systems, heavy equipment, factory automation applications and more.

Application Photo

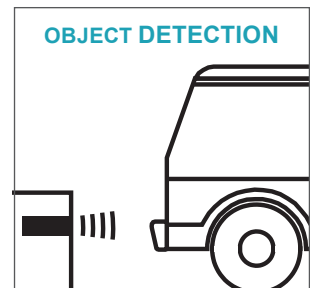
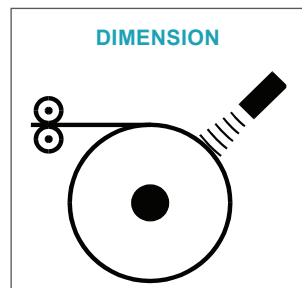
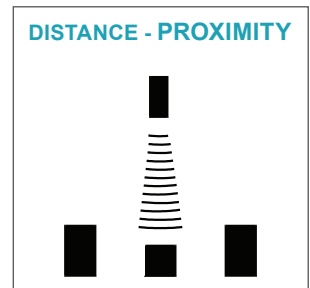
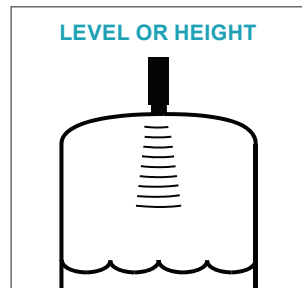
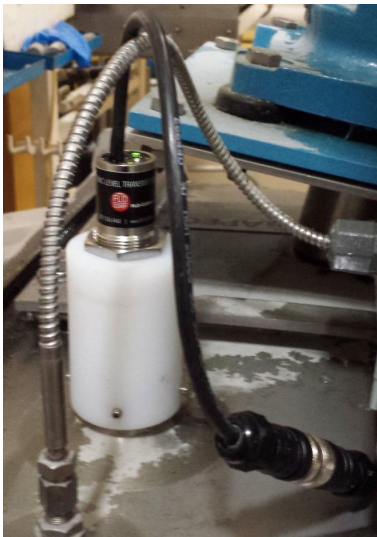

Features and Benefits

- Long range, short dead band
- Unaffected by optical factors like color and transparency
- PC or button "teachable" setup
- Narrow beam adjustments to optimize performance
- Temperature compensated
- Quick mounting
- 1.18 inch (30 millimeter) type 316 stainless steel housing
- Sealed epoxy potting for wet and dirty applications
- Ruggedized piezoelectric ultrasonic transducer, potted in place
- Hardened internal electronics
- UV resistant, potted-in cable
- Short and overload protected input / output

Specifications

Ranger One™ LTRP-1
Ultrasonic Level Transmitter



Specifications

Maximum Range	14 feet (4.3 meters)
Optimum Range	4 inches - 10 feet (102 millimeters - 3 meters)
Process Connection	30 x 1.5mm Thread
Accuracy	Better than 0.5% of target distance in stable, homogeneous air environment; affected by temperature gradients, target echo strength, speed of sound in vapors.
Power Input	10 - 30 VDC @ 60 mA maximum; typical 45 mA @ 24 VDC
Temperature	-40° to 158° F (-40° to 70° C)
Humidity	0 to 100% operating
Compensation	Temperature Compensation
Adjustment	Button "teach" or software
Configuration	Stored in non-volatile memory
Outputs	Two selectable, plus serial data
Current / Volt Output or Switched Outputs	Out puts on the black and white wires are software selected. The black wire options are 4-20mA current loop or switch. White wire options are 0-10 VDC or switch. Switches can be sourcing or sinking. Max current loop resistance is derated below 15 VDC input voltage.
Protection	NEMA-4X, NEMA-6P, IP68
Transducer	Ruggedized piezoelectric
Resolution	Digital: 0.0034 inches (0.086 millimeters); Analog:4099 steps (0-10 VDC), 3279 steps (4-20 mA)
Repeatability	Greater of +/-0.03 in. (0.76 mm) or Nominal 0.2% of range @ constant temp. Affected by target, distance, environment
Update Rate	20 Hz (50 ms), Software adjustable; also affected by Software filter selections
Output Selection	Voltage Voltage & 4-20 mA current loop (defaults), switches, or a combination
Voltage Output	0-10, 0-5 VDC or PC customized, 10 mA max; also push-button teachable endpoints
Current Loop	4-20 mA or PC customized, current sourcing, max. loop 450!, teachable endpoints
Sinking Switch	150 mA max. @ 40 VDC max., teachable set point & polarity, fault indication
Sourcing Switch	150 mA max. @ input voltage, teachable set point & polarity, fault indication
RS-232, RS-485	Modbus protocol, 9600 to 115200 baud, 8 data bits, 1 stop, no parity
SYNC Feature	Permits up to 32 sensors to operate in close proximity without interaction
Target Requirements	
Objects	Detects flat or curved objects. Surface must reflect ultrasound to sensor
Max. Distance	Affected by size, shape, orientation of target (sound level reflected back to sensor), environment. Restrict use to Optimum Range when using over a wide range of environmental conditions
Orientation	Flat surfaces should be oriented perpendicular to sensor output beam
Optical	Unaffected by target color, light, transparency or other optical characteristics

Specifications are subject to change without notice.

Ordering Information

Ranger One™ LTRP-1
Ultrasonic Level Transmitter



Dimensions

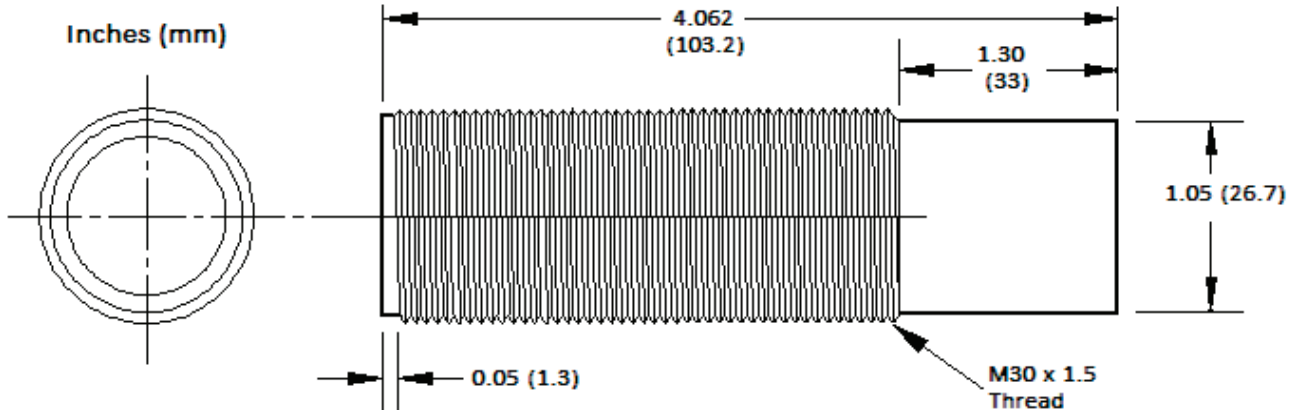

NOTES:

- Dimensions are in inches (mm)
- Mounting Hole: 1.2 in. (30.5mm) diameter
- Standard Cable: 6.5ft (2m)
- Ships with (2) 30mm stainless mounting nuts
- Total Weight: 10.40 oz (0.29kg)

Ordering Information

HAWK Model Number Builder

Use the diagram below, working from left to right to construct your HAWK Model Number. Simply match the category number to the corresponding box number.

Example: **LTRP-1-485**

Ranger One™ Ultrasonic Level Transmitter (Up to 14ft) with RS-485 Communication Interface

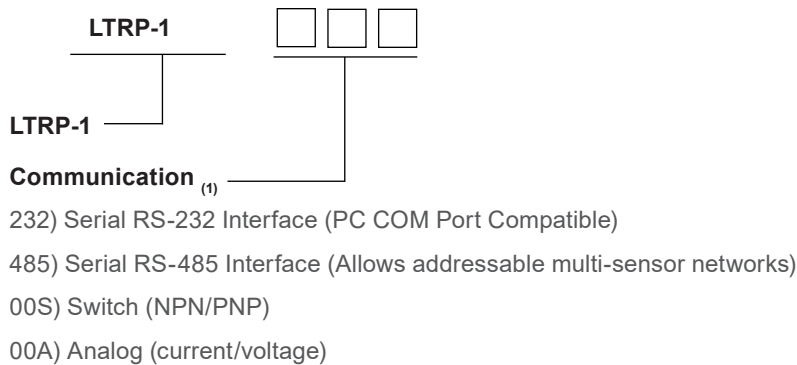

Potted sensor with "Teach" Button

Ordering Notes:

(1) Select the best probe type based on your requirements

Hawk Measurement Systems (Head Office)

15 - 17 Maurice Court, Nunawading VIC 3131, AUSTRALIA

Phone: +61 3 9873 4750

Fax: +61 3 9873 4538

info@hawk.com.au

Hawk Measurement

5010 Gateway Drive, Medina, OH 44256, USA

Phone: +1 888 HAWKLEVEL (1-888-429-5538) / +1 978 304 3000 / +1 877-356-5463

Fax: +1 978 304 1462 / +1 330-331-7172

info@hawkmeasure.com

For more information and global representatives: www.hawkmeasurement.com

Additional product warranty and application guarantees upon request.

Technical data subject to change without notice.