

A Higher Level of Performance



Manual

UltraFlo™ UFD3

Ultrasonic Clamp-on Flow Meter



Fixed Option

Portable Option

For more information, please visit >

www.hawkmeasurement.com



Operating Instructions

UltraFlo™ UFD3

Ultrasonic Clamp-on Flow Meter



Introduction

Please read carefully! No liability can be accepted for damage caused by improper use or installation of the UltraFlo™ Ultrasonic Flow Meter.

The UltraFlo™ UFD3 ultrasonic flow meter is a fixed or portable, clamp-on flow meter that is easy to install, accurate, and simple to use. The UltraFlo™ UFD3 is equipped with intelligent software to ensure high accuracy and low velocity response. The flow meter has the ability to be a fixed unit or portable unit. The UltraFlo™ UFD3 ultrasonic flow meter is widely used in applications such as oil and gas, water treatment, pure water, chemical, and much more.



Safety Precautions

If you are unsure of the suitability of a UltraFlo™ Ultrasonic Flow Meter for installation, please consult your HAWK representative for further information.

Flammable or Explosive Applications

HAWK manufactures several different display models with different mounting and internal configurations. It is the user's responsibility to select a controller model that is appropriate for the application, install it properly, perform tests on the installed system, and maintain all components.

Disclaimer

The information contained in this document is subject to change without notice. HAWK makes no representations or warranties with respect to the contents hereof and specifically disclaims any implied warranties of merchantability or fitness for a particular purpose.

Incorrect Wiring

HAWK assumes no responsibility for users incorrectly wiring their UltraFlo™ Ultrasonic Flow Meter. Please refer to the wiring diagrams for correct wiring of the UltraFlo™ Ultrasonic Flow Meter.

Operating Instructions

UltraFlo™ UFD3

Ultrasonic Clamp-on Flow Meter



Principle of Operation

The UltraFlo™ is a clamp-on type ultrasonic flow meter which uses the digital transfer time technology to measure flow of practically any liquid. The wide application of the UltraFlo™ meter includes application in the oil industry, water treatment, pure water, waste water with solids, chemicals and more. What makes the UltraFlo™ flow meter unique is the ability to measure and calculate flow rates with high accuracy and very low velocity, under 1 foot per second. The UltraFlo™ also has the ability to add an RTD temperature sensor to compensate for cold fluid applications (under 56°F) as well as become an energy meter to monitor the energy use in a chiller or cooling tower.

Technology

The calorimetric flow meter measures continuous flow by detecting heat change in the media as it flows by the sensor. For reference, calorimetric flow meters are often used in air conditioning, dust collection, energy conservation systems, potable/non-potable water, sulfuric acid, and ventilation monitoring.

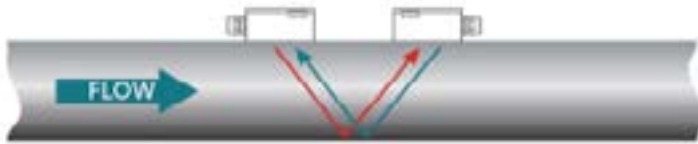

Typical Applications



Agriculture



Minerals & Mining



Chemical & Petrochemical



Oil & Gas



Environmental Water & Wastewater



OEM



Life Sciences



Power & Energy

Operating Instructions

UltraFlo™ UFD3

Ultrasonic Clamp-on Flow Meter



Specifications

PERFORMANCE	
FLOW RANGE	±0.09ft/s ~ ±40ft/s (±0.03m/s ~ ±12m/s)
ACCURACY	±0.5% of reading (for ±1.5ft/s~±40ft/s)
REPEATABILITY	0.15% of measured value
LINEARITY	±0.5%
PIPE SIZE	1" to 200" (25mm to 5000mm). Pipe size under 1" is an option
FUNCTION	
OUTPUTS	Analog output: 4~20mA, max load 750Ω. Pulse output: 0~9999Hz, OCT, (min. and max. frequency is adjustable) Relay output: SPST, max 1Hz, (1A@125VAC or 2A@30VDC)
COMMUNICATION	RS232 & RS485
MEMORY	TF card (Max 4G)
POWER SUPPLY	90 to 245 VAC, 48 to 63 Hz. Or 10 to 36VDC
DISPLAY	240*128 back lit LCD
TEMPERATURE	Transmitter: -40°~140° (-40°~60°) Transducer:-40°~176° (-40°~80°, standard)
HUMIDITY	Up to 99% RH, non-condensing
PHYSICAL	
TRANSMITTER	IP65
TRANSDUCER	IP68 Encapsulated design Double-shielded transducer cable Standard/maximum cable length: 30ft/900ft (9m/274m)
<i>Specifications are subject to change without notice.</i>	

Operating Instructions

UltraFlo™ UFD3

Ultrasonic Clamp-on Flow Meter



Dimensions

Transmitter - Fixed Option

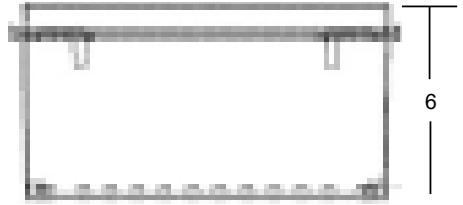
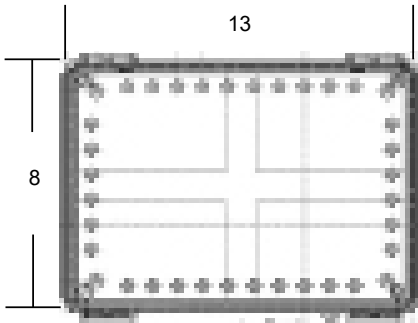

Transducer

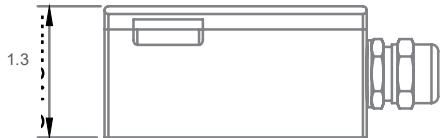
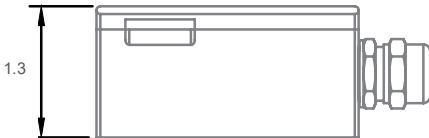
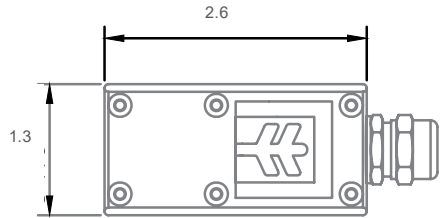
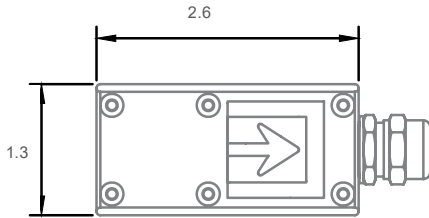

Operating Instructions

UltraFlo™ UFD3

Ultrasonic Clamp-on Flow Meter



Installation and Instructions

1.0 Power Supply

The power supply for the unit can be connected to either the AC 90 - 245 VAC power terminals or the DC 10 - 36 VDC power terminals. Please make sure that either option, but not both at the same time are used. The AC power option is connected to the terminal strip marked L and N - AC 90 - 245 VAC. This terminal location is on the far left of the terminal strip. The DC power option is connected to the terminals marked DC+ and DC- - DC 10-36V. This terminal location is right of the AC terminal location.

1.1 Transducer Connection

The transducers are connected through the multi-pin connector located on the bottom of the UltraFlo flow meter enclosure and connected to the mating connector terminated on the end of the transducer cables. The Transducer wire colored RED is for the UPSTREAM transducers and the wire colored BLUE is for the DOWNSTREAM transducers. There is also an arrow indicator on the body of the transducers.

Caution: Wiring should be made with power off. Use either AC or DC power supply. Do not connect both of them at the same time.

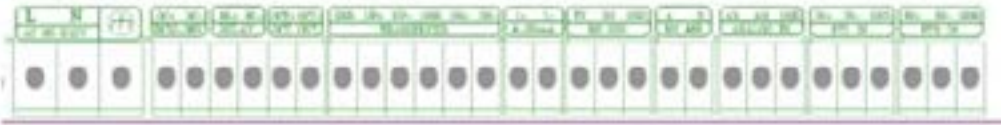

1.3 Power UltraFlo™ On

As soon as the flow meter is switched on, the system will run automatically according to the last input parameters stored in memory. No loss of data will occur during power down mode. If the transducers are already placed on the pipe or installed, the auto-gain adjustments can be monitored in screen #M01. After code "R" is displayed on the upper left corner of the screen, the system will activate to the normal measurement condition automatically. Run mode is indicated by the code "R" on the upper left corner of the screen. If this is the initial or first installation for the metering location, parameters will need to be programmed into the flow meter via the keypad to the right of the screen. This manual will provide instructions for the basic parameters that will need to be programmed using this keypad. All parameters that are programmed into the meter will be saved automatically even after power down until they are changed by the user.

1.4 Keypad Operation

Input parameters and modifications by entering into specific menu options on the display. Each menu options has its own menu code or ID code and has a defined meaning. For example, menu code M10 indicates the parameter input for the pipe outside diameter. menu code M14 indicates the mounting spacing between the transducers.

Operating Instructions

UltraFlo™ UFD3

Ultrasonic Clamp-on Flow Meter





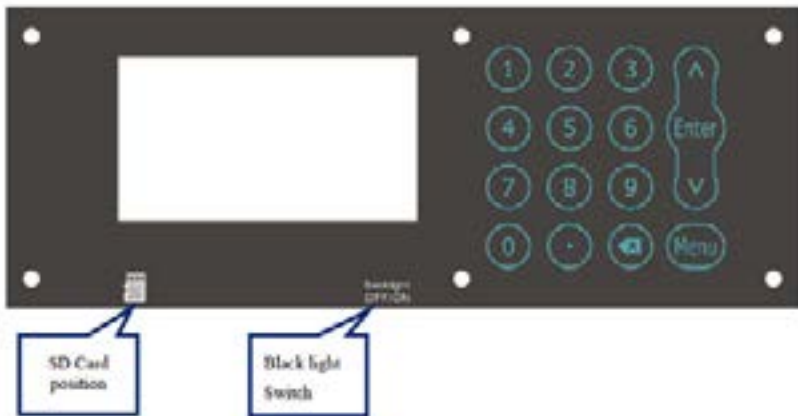

The keypad shortcut to visit a specific window is made by pressing the MENU key at any time. Next, press the 2 digit menu code. For example, to input or check the pipe outside diameter, press the MENU key and the 1 and 0 key on the keypad. You can then scroll up or down the menu codes by pressing the UP or DOWN arrows on the keypad. Example, you can view menu code M11 (Pipe Liner Setting) by pressing the UP arrow once. Menu Code M12 (Liquid Settings) by pressing the UP arrow again, and so on. If you want to modify the parameter within the menu code, input the digits and press the ENTER button, input the digits and press ENTER again to confirm.

NOTE 1: The x-Back key (to the left of the MENU key) should be used to go back to last desired function and to back out of the parameter that you were setting after you enter the parameter.

NOTE 2: The > symbol will be displayed in the window once Enter is pressed to edit a parameter value. Once the value is edited, press Enter again and the > will extinguish.



- Numbers "0-9" and  Input Numbers or Menu Code
-  Backspace or delete characters to the left or back to the previous menu.
-  and  Return to the last menu or open the next menu. Acts as "+" and "-" are used to enter numbers.
-  Select a menu. Press this key first, then input two menu numbers to display the selected menu.

Operating Instructions

UltraFlo™ UFD3

Ultrasonic Clamp-on Flow Meter



2.0 Basic Settings

Step 1. Pipe Size Settings - M10

Press the Menu key and the 1 and 0 key on the keypad. Press ENTER. To edit pipe OD, Press Enter again. On the display, the OD size will be erased and you can enter a new OD size in the window by pressing the numeric value of the pipe OD using the numeric key pad. Press Enter Enter the outer diameter of the pipe size and press enter to confirm.

Step 2. Pipe Material - M10

Pipe Material is selected in the M10 window in the center box under the Pipe Settings on the display - The box will display an M in it. The M is for Material. To select a different pipe material or speed of sound for the pipe material, press ENTER. a listing of the pipe material to select is below:

- | | | |
|-----------------------------|-------------------------------|-----------------------------|
| 0. PVC | 3. CIP Cast Iron Pipe | 6. Alu Aluminum pipe |
| 1. CS Carbon Steel | 4. DIP Ductile Cast Iron Pipe | 7. ACP Asbestos Cement Pipe |
| 2. SSP Stainless Steel Pipe | 5. Copper | 8. FPG Fiberglass Pipe |
| | | 9. Other |

Step 3. Once the pipe settings, size and material are entered, press MENU key 1 and 2, M12. The display will switch to the Medium or liquid type window. Press ENTER to edit the medium, Press ENTER again. The > symbol will be displayed next to a number and liquid type. Press the up or down arrow to edit the liquid type and press enter again to select and enter the correct selection. Select from the material list:

- | | | |
|--------------------|---------------|---------------------|
| 0. Water | 5. Fuel Oil | 10. Alcohol |
| 1. Water 125 deg C | 6. Crude Oil | 11. Propane (-45°C) |
| 2. Seawater | 7. Diesel Oil | 12. Butane (0°C) |
| 3. Kerosene | 8. Castor Oil | 13. Gas #93 |
| 4. Gasoline | 9. Peanut Oil | 14. Other |

Step 4. M14 will display the Transducer Spacing required to measure the flow in the pipe. This value will be provided on the display once the liquid type (M13), pipe material and pipe diameter (M10) settings are entered correctly. Ensure that the transducer spacing is measured during installation.

NOTE 3: The spacing between the ENDS facing each other is considered as the edge that the transducer spacing must be gauged.

NOTE 4: There are 2 types of mounting methods that can be used. V method, which is used most commonly for most applications with pipe sizes up to 20 inch OD, and Z method when the pipes are larger than 20" or large degree of suspended solids, scaling or the pipe liner is too thick. The Z method installation has less signal attenuation than a signal using the V method. The V method is the standard method used.

NOTE 5: Make sure enough acoustical coupling is used on the transducer face which makes contact with the surface area of the pipe. Use more than less. Acoustical coupling is supplied with the flow meter. If additional coupling is required, please contact the factory.

Operating Instructions

UltraFlo™ UFD3

Ultrasonic Clamp-on Flow Meter



NOTE 6: Use the pipe clamps supplied with the meter. Insert the pipe clamp into the slot provided on the transducer and around the pipe OD. Tighten to make sure the transducers do not move due to pipe vibration. Do not over-tighten.

NOTE 7: The transducers should be mounted in the 3 o'clock or 9 o'clock position. Never install at the 12 or 6 o'clock position. Mount on a horizontal pipe with a min. of 10 pipe diameters upstream and 5 pipe diameters downstream of any pipe bend, valve, elbow or obstruction in the pipe.

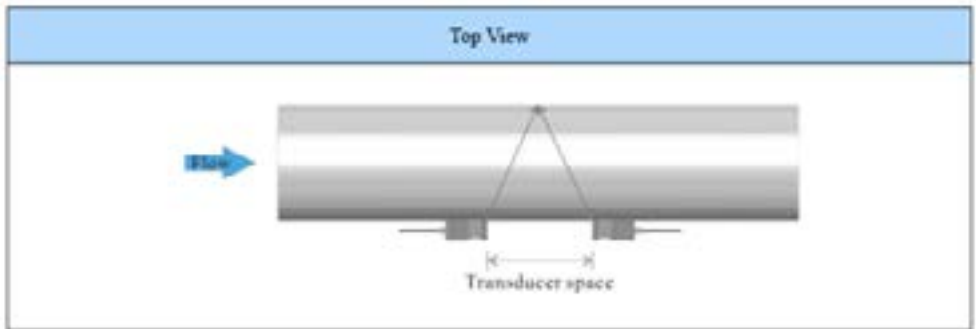

Operating Instructions

UltraFlo™ UFD3

Ultrasonic Clamp-on Flow Meter



Window Display Codes

CODE	DESCRIPTION	CLASS	
M0X	Display Value and Condition *R - System Normal *E - Signal Not Detected *D - Adjusting Gain	M00: Flow Totalizer M01: Flow Rate	M02: Energy Totalizer M04: Status
M1X	Installation Setting	M10: Pipe Settings M11: Lining Settings M12: Liquid Settings	M13: Transducer Settings M14: Installation Space
M2X	Calibration Setting	M20: Damping M21: Low Flow Cut Off Valve M22: Zero Point Settings M23: Energy Totalizer Settings	M24: Temperature Sensitivity Settings M25: Automatic Flow Correction M26: K Factor Setting M27: Linear Calibration Settings
M3X	Input and Output Settings	M30: Serial Port Parameter M31: AI Settings M32: 4-20mA Settings M33: OCT Settings	M34: Relay Settings M35: Alarm Value Settings M36: Flow Batch Settings M37: Micro SD Settings
M4X	Flow Unit Options	M40: Metric System Units M41: Flow Rate Units	M42: BTU Units M43: Temperature Units
M5X	System Settings	M50: Serial Number M51: Time and Date M52: Beeper Setup	M53: Initial Interface Settings M54: System Lock Settings M55: Restore Factory Settings
M6X	Other	M60: Date Totalizer M61: Working Time M62: 4-20mA Calibration	M63: RTD Calibration M64: AI Calibration

Example of display settings

M00

Flow Total

Display Net Totalizer.

Display Positive totalizer.

Display Negative totalizer.

Use  and  to switch.

M01

Flow Rate

Display the Flow Rate.

Display the Velocity.

Use  and  to switch.

Contact

UltraFlo™ UFD3

Ultrasonic Clamp-on Flow Meter



Ordering Information

HAWK Model Number Builder

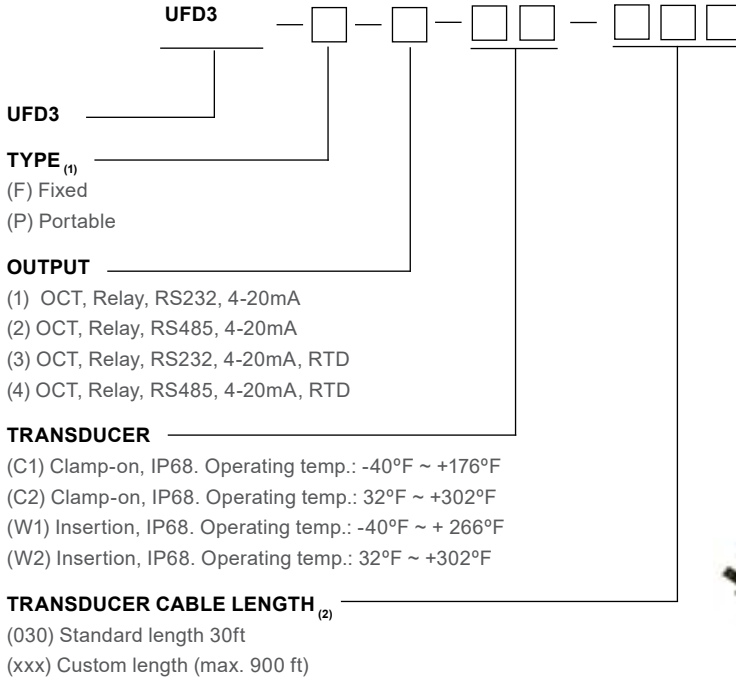

Fixed Option



Portable Option

Ordering Notes:

- (1) Select the best configuration based on your requirements
- (2) Enter length in feet, maximum 900ft. Example: 89 feet required, enter 089

Hawk Measurement Systems (Head Office)

15 - 17 Maurice Court, Nunawading VIC 3131,
AUSTRALIA

Phone: +61 3 9873 4750

Fax: +61 3 9873 4538

info@hawk.com.au

Hawk Measurement

5010 Gateway Drive, Medina, OH 44256, USA

Phone: +1 888 HAWKLEVEL (1-888-429-5538) /

+1 978 304 3000 / +1 877-356-5463

Fax: +1 978 304 1462 / +1 330-331-7172

info@hawkmeasurement.com

For more information and global representatives: www.hawkmeasurement.com

All company or product names are registered trademarks or trademarks of their respective owners.

